

등급	공차		
	I	II	III
범위			
0 ~ 4 이하	±0.1	±0.2	±0.3
4 ~ 16 이하	±0.2	±0.3	±0.5
16 ~ 63 이하	±0.3	±0.5	±0.8
63 ~ 250 이하	±0.5	±0.8	±1.2
250 ~ 1000 이하	±0.8	±1.2	±2.3
1000 ~	±1.5	±2.3	
경도			
표면거칠기			

접시머리 M4x10I 용무
접시머리 4?x16L 1중 탭핑

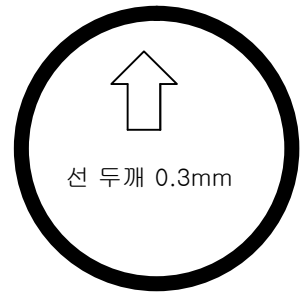
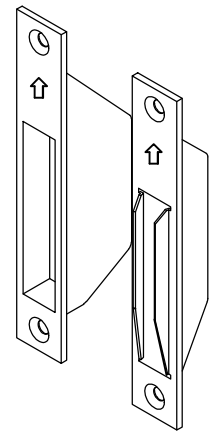
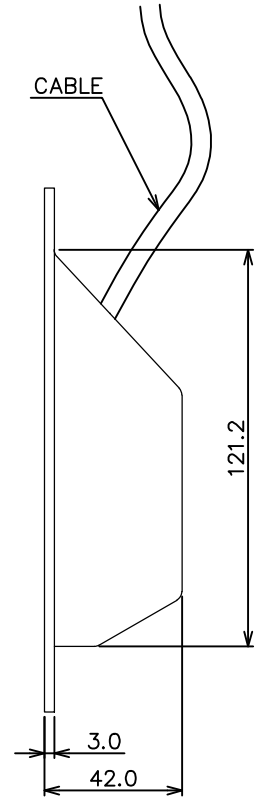
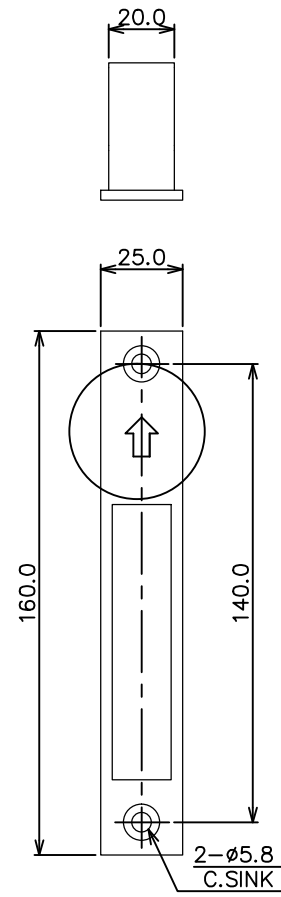
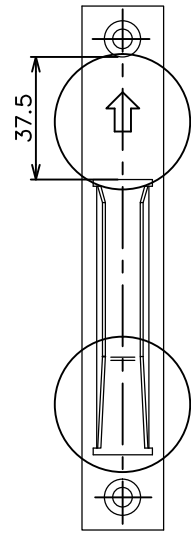
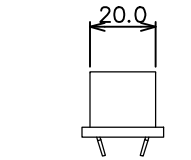
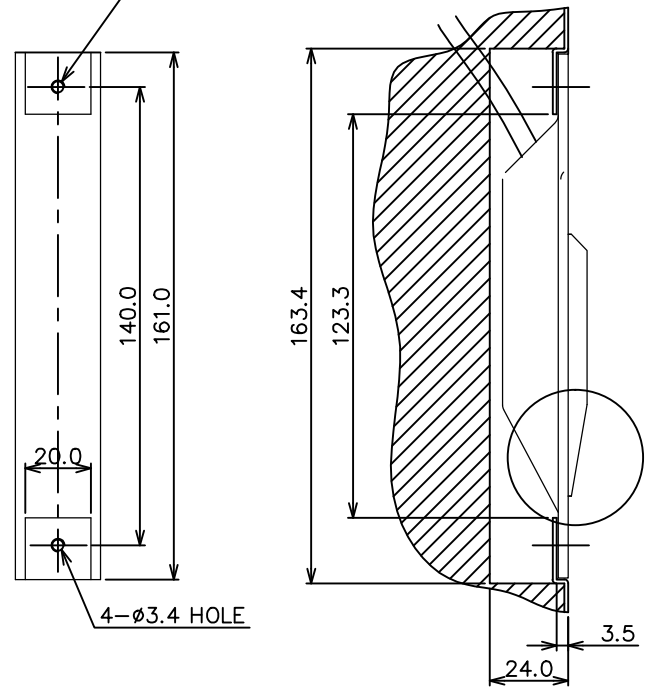

NOTE

1. -

C	B	A	NO.	DWG. NO.	PART NAME	SPEC'	MATERIAL	Q'TY	REMARK
						▶MODELPT-6C		▶Q'TY	▶SIZE A3
						▶SURFACE -	▶PART NAME	설치도	
						▶DRAWN	▶REVIEW	▶APPROVAL	SLPT-6C
				2011.12.12					▶SCALE NONE
						▶DWG. NO.	SLPT-6C-01		▶SHEET
						▶CODE			▶REV.